

Porte scorrevoli in alluminio portata 80kg

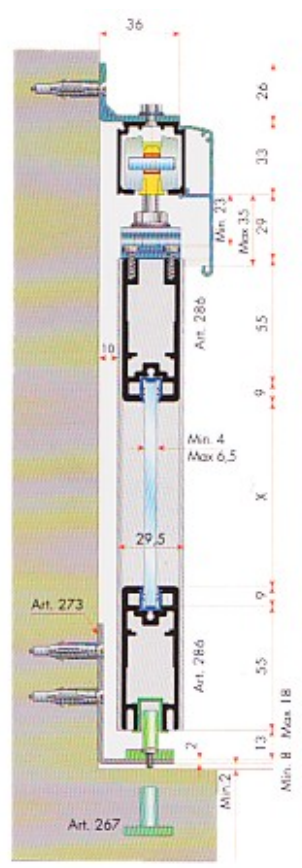

Ternoscorrevoli porta alluminio

Porte scorrevoli in alluminio porata 80 kg.

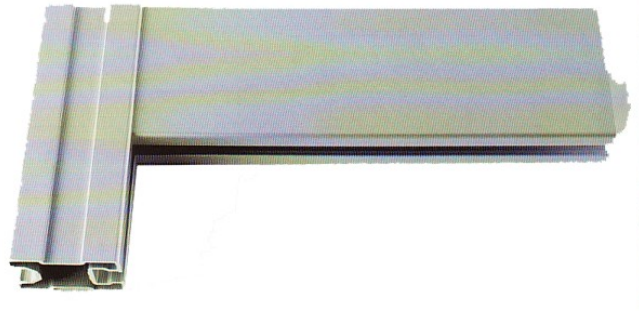
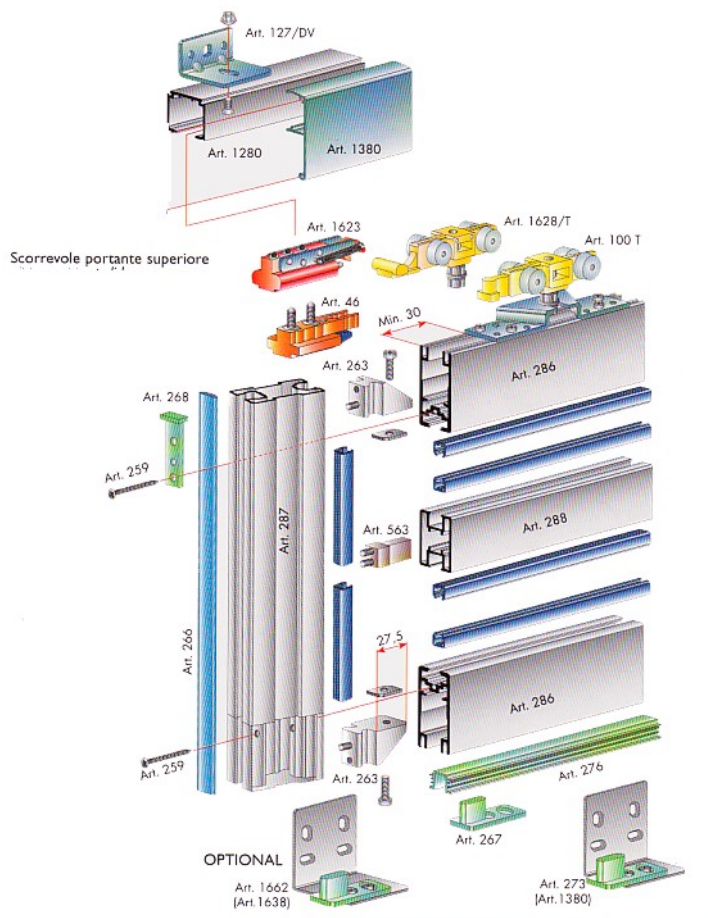
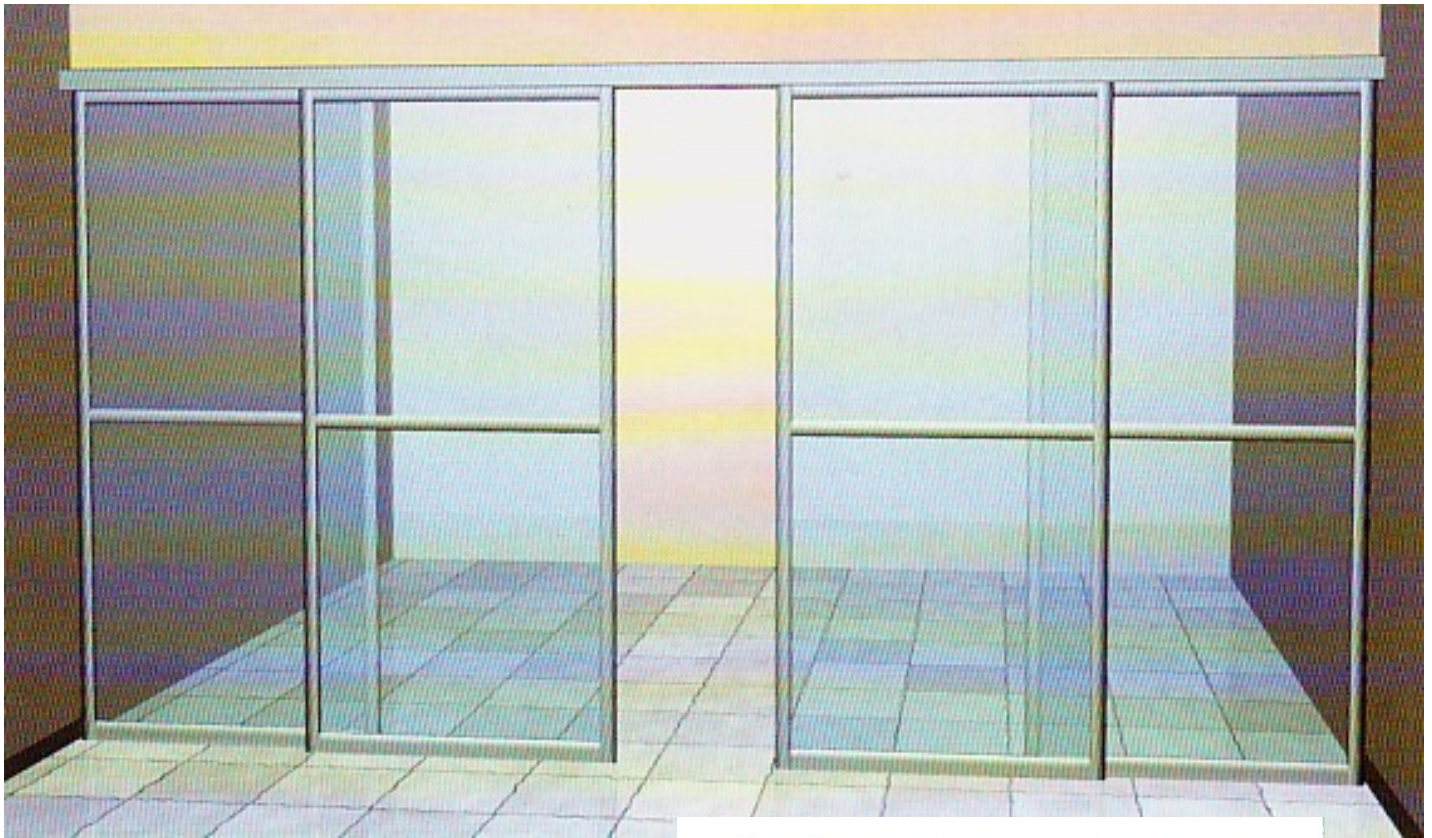
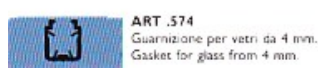
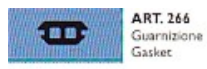
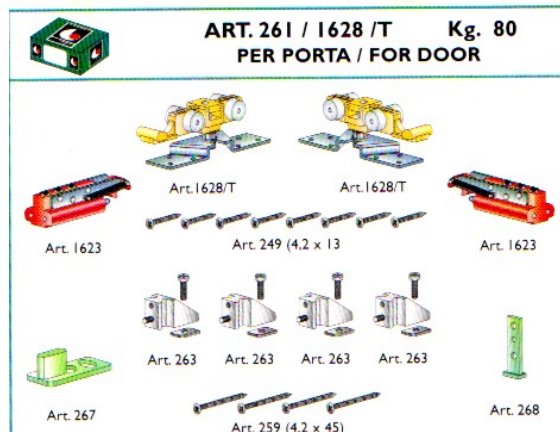
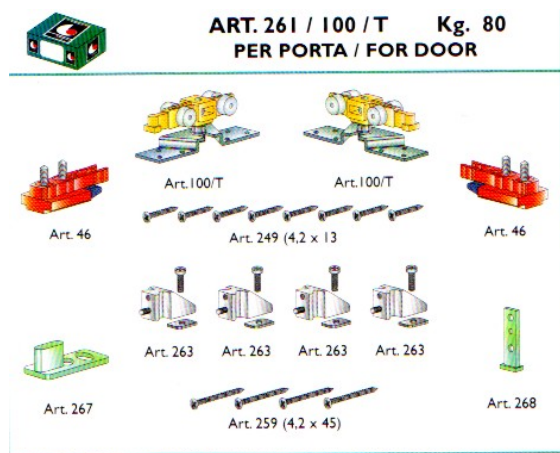

CHIUSURA BLUMOSCION

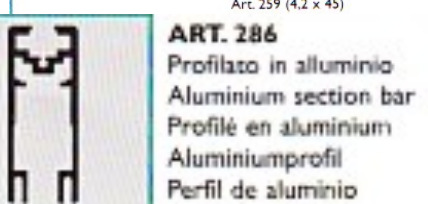

ART.	DESCRIZIONE	
1280	BINARIO ALLUMINIO	
1380	COPERTURA BINARIO	
261/1628T	KIT CARRELLI	BLUMOSCION
286	PROFILO SUPERIORE E INFERIORE	
287	PROFILO LATERALE DX-SX	
288	TRAVERSA IN ALLUMINIO	
574	GUARNIZIONE PER VETRO 4mm	
266	GUARNIZIONE DI BATTUTA	
563	TASSELLO PER GIUNTURA TRAVERSA	

Armadi scorrevoli in alluminio

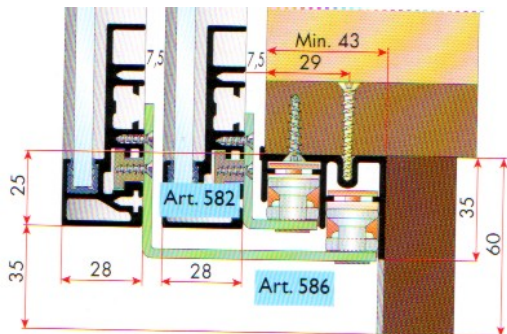
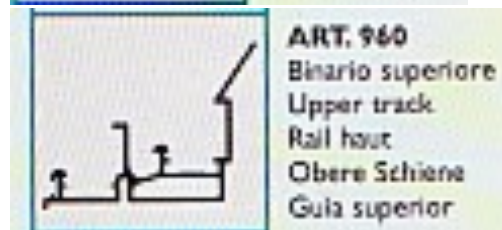
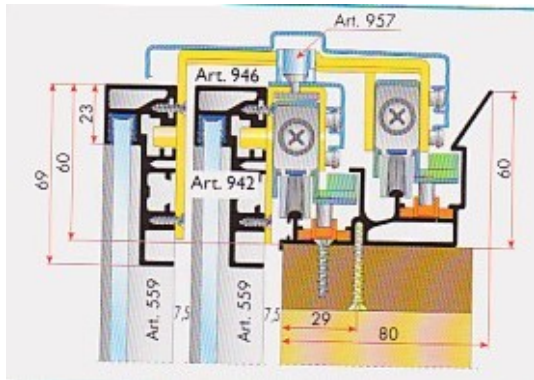
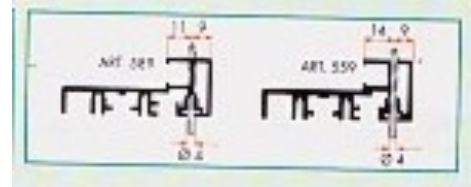
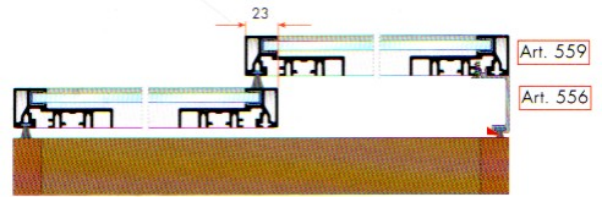
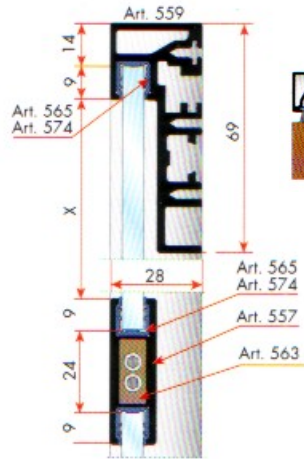
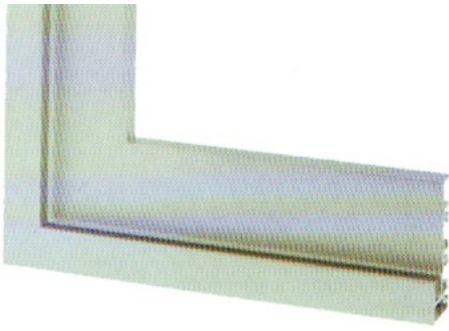

ART.	DESCRIZIONE
960	BINARIO ALLUMINIO SUP
910	BINARIO ALLUMINIO INF
559	PROFILO ALLUMINIO
557	PROFILO TRAVERSA
563	TASSELLO PER TRAVERSA
574	GUARNIZIONE PER VETRO 4mm
942-582-559	KIT CARRELLI ANTA INTERNA
942-586-559	KIT CARRELLI ANTA ESTERNA

Profilo alluminio per creare ante a cerniera ante scorrevoli ante a ribalta.

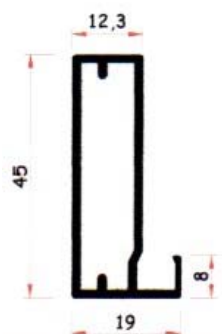
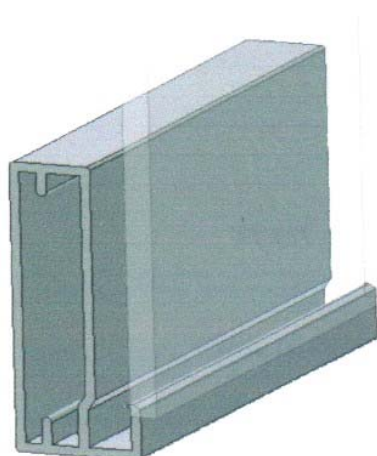

Squadretta

ART.	DESCRIZIONE
PRZ12314AL	Profilo ALLUMINIO ANOTIZZATO
GUZ12314	Guarnizione per vetri o metacrilato da 4 mm
SQZ12314	Squadretta di giunzione

Anta alluminio a cerniera

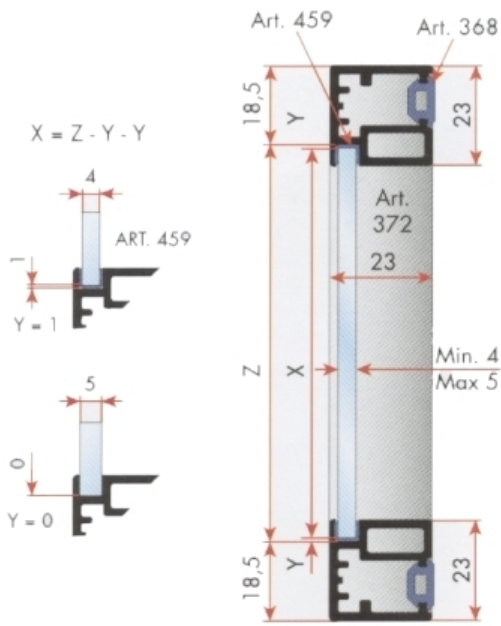

CERNIERE SALICE

- C206A99 COLLO 0 / S = 20
- C206D99 COLLO 5 / S = 15
- C206G99 COLLO 9 / S = 11

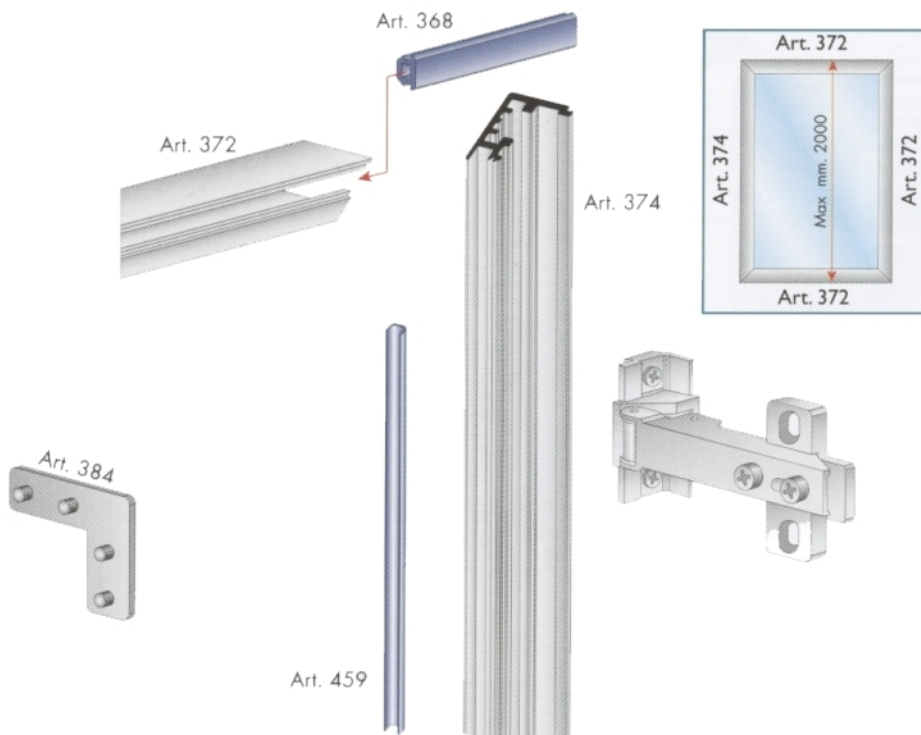
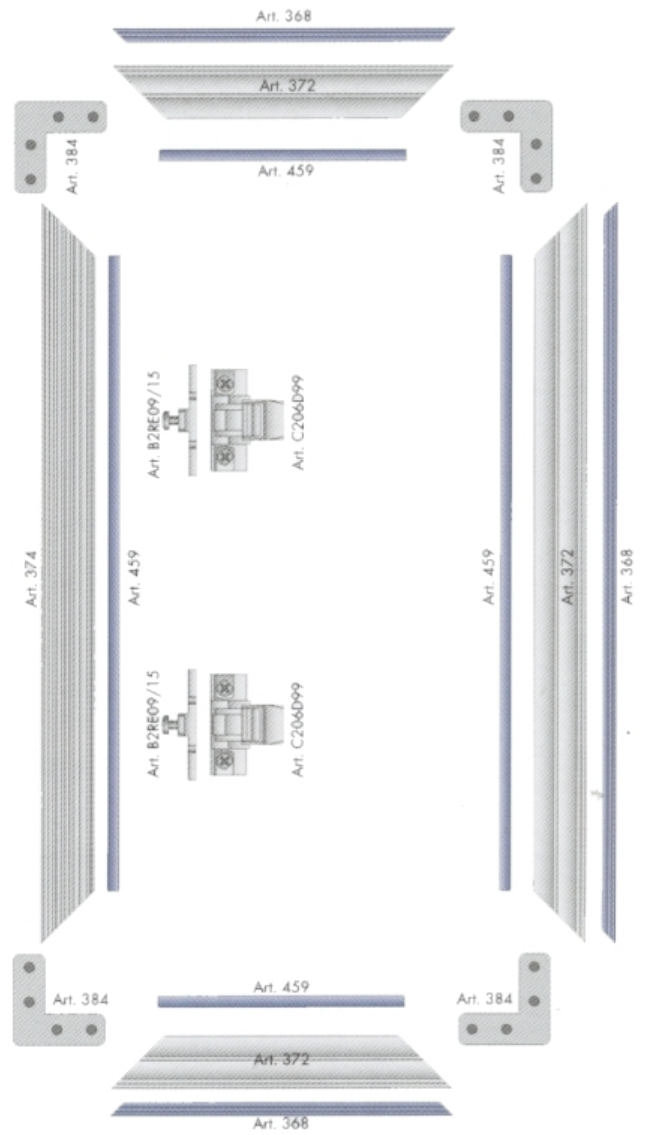
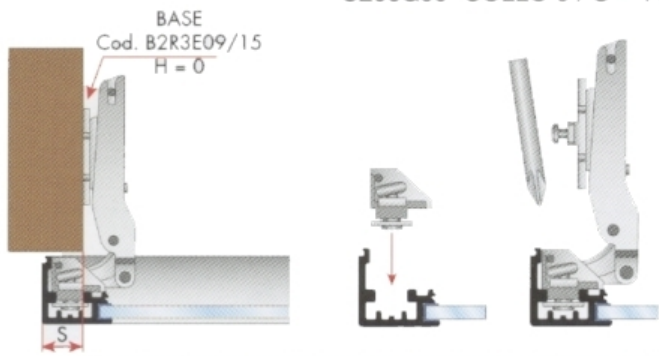

Anta alluminio a cerniera

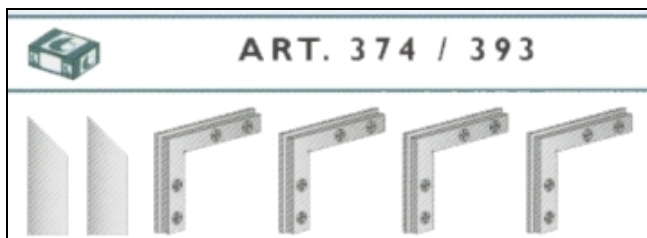
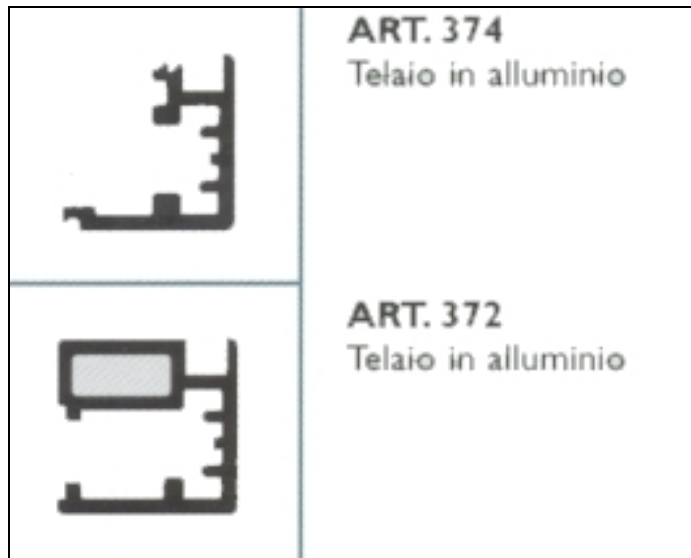

CERNIERE SALICE

C206A99 COLLO 0 / S = 20
 C206D99 COLLO 5 / S = 15
 C206G99 COLLO 9 / S = 11

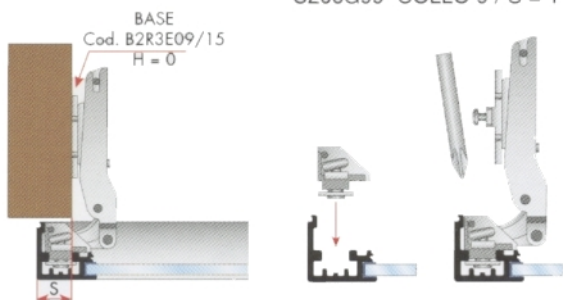

ART.	DESCRIZIONE
374	PROFILO LATERALE PER CERNIERE
372	PROFILO SOPRA SOTTO E 1 LATO
374/393	KIT ANGOLI
459	GUARNIZIONE PER VETRO 4mm
368	GUARNIZIONE DI COPERTURA
461	COPERTURA PROFILO LATO CERNIERE

Antaribalta alluminio

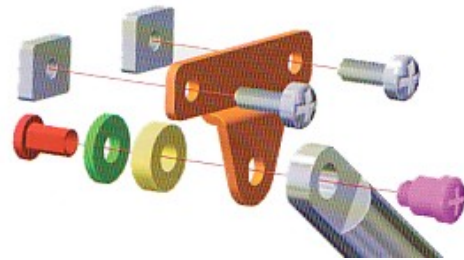
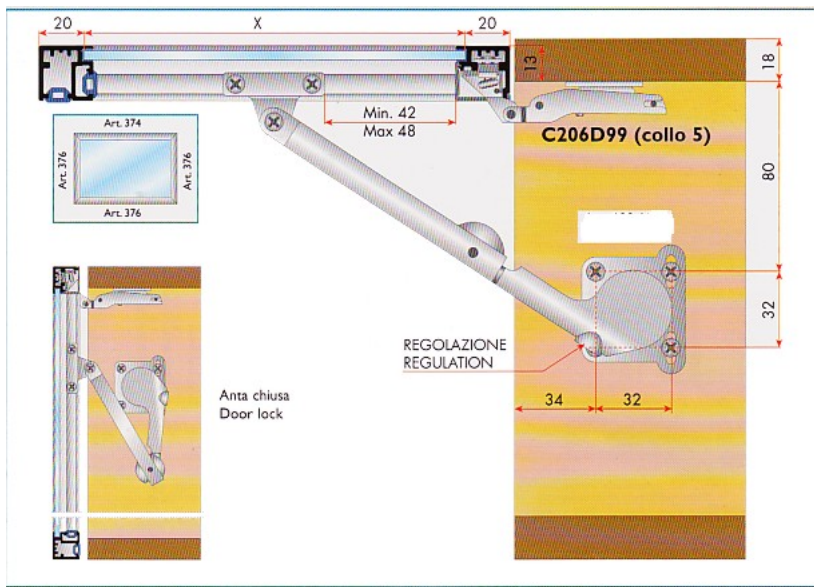
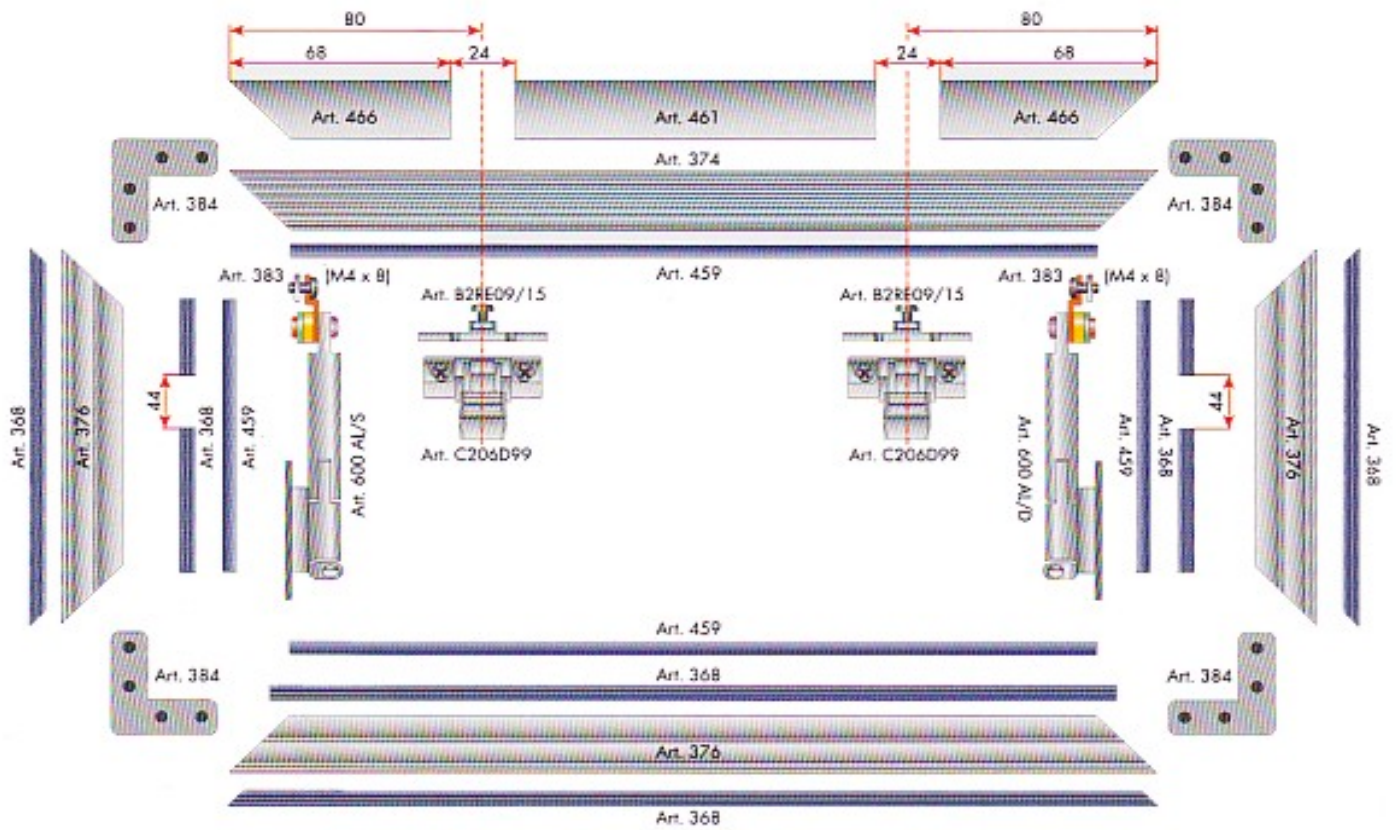

ART. 374 / 393



ART. 376

Telaio in alluminio
Aluminium frame
Châssis en aluminium
Aluminiumrahmen
Bastidor de aluminio

ART. 461

Copertura in alluminio
Aluminium cover
Gaine de protection en aluminium
Abdeckprofil
Cobertura de aluminio

ART. 374

Telaio in alluminio
Aluminium frame
Châssis en aluminium
Aluminiumrahmen
Bastidor de aluminio

ART. 368
Guarnizione
Gasket
Garniture
Dichtung
Guarnición

ART. 459
Guarnizione per vetro da 4 mm.

Antaribalta alluminio

ART.	DESCRIZIONE
374	PROFILO SUPERIORE E INFERIORE
376	PROFILO LATERALE DX-SX
374/393	KIT ANGOLI
459	GUARNIZIONE PER VETRO 4mm
368	GUARNIZIONE DI COPERTURA
461	ANGOLARE DI COPERTURA
600	BRACETTO 600
C206A99	CERNIERE SALICE ALLUMINIO BATTENTE
C206G99	CERNIERE SALICE ALLUMINIO MEZZO BATTENTE
C206D99	CERNIERE SALICE ALLUMINIO FILO

TERNOSCORREVOLI ANTA RIBALTA

Scorrevoli alluminio 20 Kg.

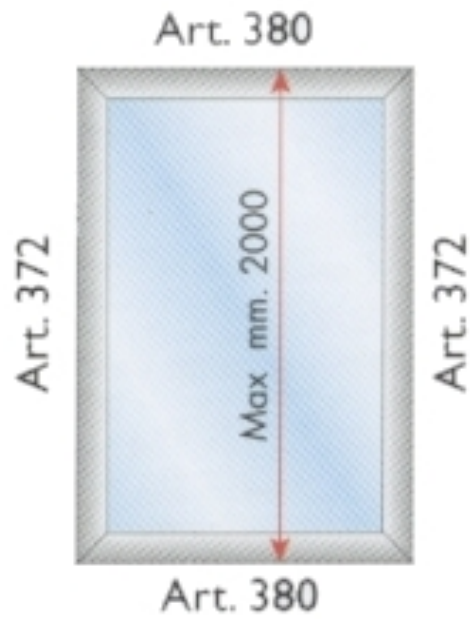
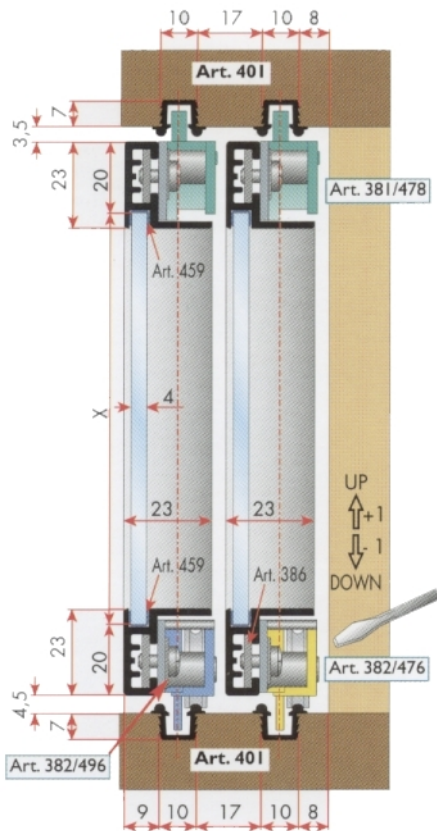
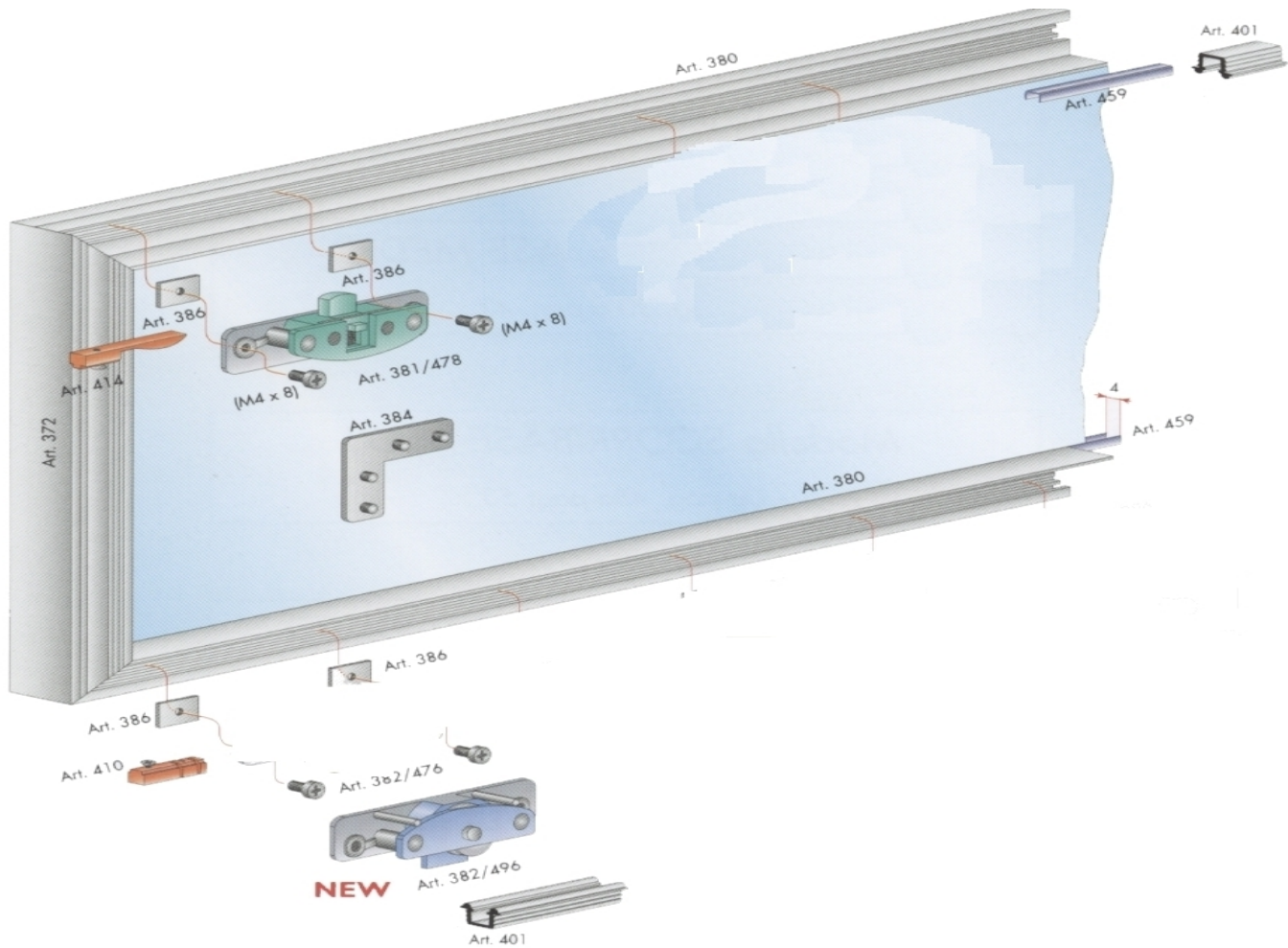

Anta alluminio scorrevole Kg. 20

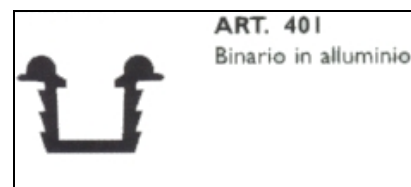
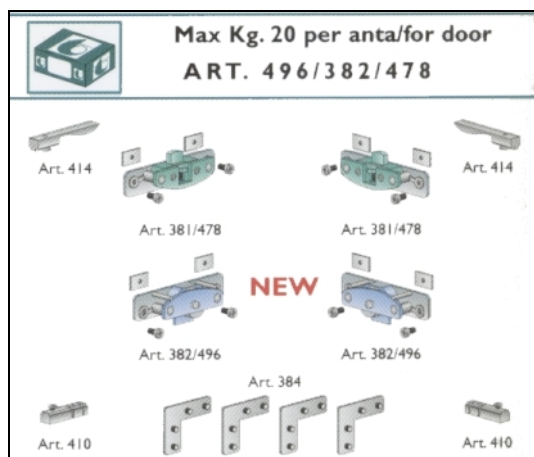

ART.	DESCRIZIONE
401	BIMARIO SUPERIORE E INFERIORE
380	PROFILO SUPERIORE E INFERIORE
372	PROFILO LATERALE
496-482-478	KIT CARRELLI
459	GUARNIZIONE PER VETRO 4mm

Anta alluminio scorrevole Kg.30

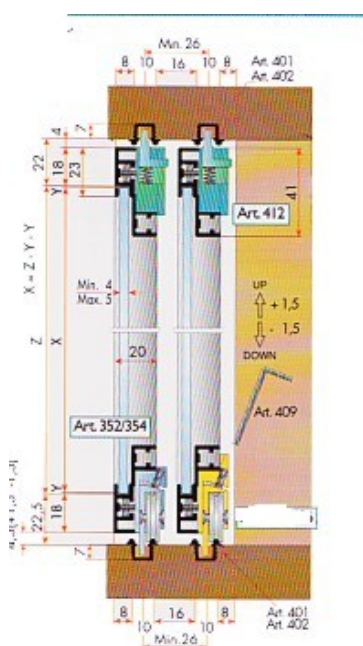
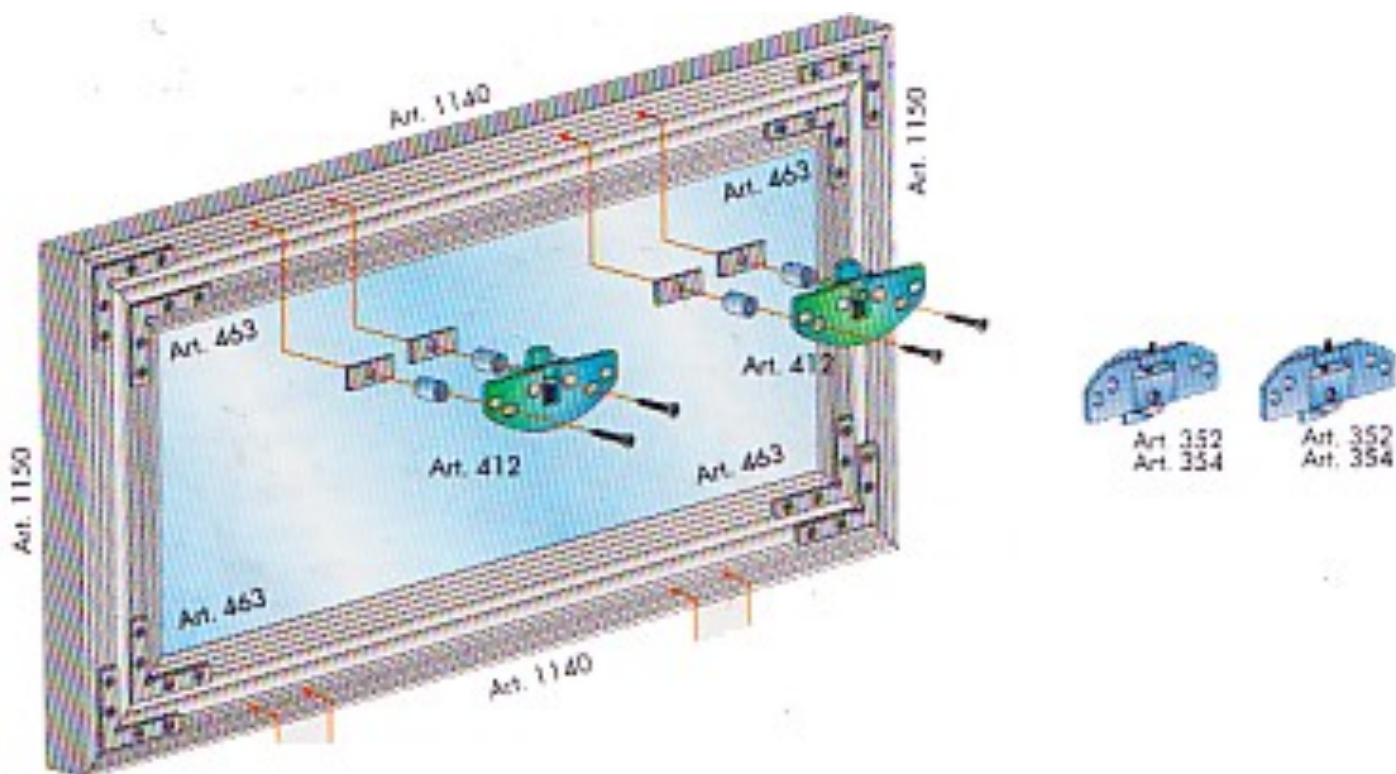

ART. 352-412-1140/T Kg. 30
ART. 354-412-1140/T Kg. 30

Parts list for the roller assembly:

- Art. 414 (Roller)
- Art. 412 (Roller)
- Art. 412 (Roller)
- Art. 414 (Roller)
- Art. 410 (Bracket)
- Art. 352/354 (Bracket)
- Art. 352/354 (Bracket)
- Art. 410 (Bracket)
- Art. 409 (L-Bracket)
- Art. P/B/M 4 x 18 (Screw)
- N° 8 (Screw)
- N° 8 (Screw)
- Art. 463 (Bracket)

NEW



ART. 401
 Binario in alluminio
 Aluminium track
 Profilé en aluminium
 Aluminiumschiene
 Guia de aluminio



ART. 1140
 Telaio superiore e inferiore
 Top and bottom frame
 Huisserie du haut et du bas
 Oberer und unterer Rahmen
 Bastidor superior e inferior

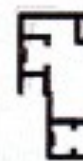

ART. 1150
 Telaio laterale
 Lateral frame
 Huisserie latérale
 Seitenrahmen
 Bastidor lateral

ART. 459
 Guarnizione per vetro da 4 mm.



Anta alluminio scorrevole Kg. 30

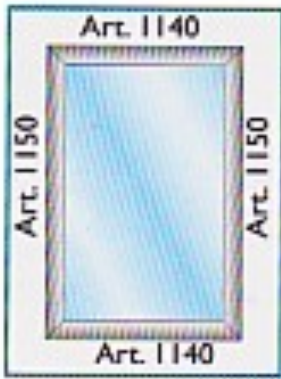

ART.	DESCRIZIONE
401	BIMARIO SUPERIORE E INFERIORE
1140	PROFILO SUPERIORE E INFERIORE
1150	PROFILO LATERALE
352-412-1140	KIT CARRELLI
459	GUARNIZIONE PER VETRO 4mm

Ternoscorrevoli 1140-1150